R-T12100B/T12200B/T12300B User Manual



TOPBAND

Lithium Iron Phosphate Battery with Smart Monitoring

SHENZHEN TOPBAND BATTERY CO.,LTD

Address:Topband Industrial Park, Liyuan Industrial Zone, Shiyan, Bao'an, Shenzhen, China, 518108

Web: <https://www.topbandbattery.com/>

Contents

1. Safety	4
1.1 Statement	4
1.2 Specification	4
1.3 Critical safety info.	4
1.4 Battery maintaining	5
1.5 Waste disposal	6
2. Installation	6
2.1 Tools and Equipment	6
2.2 Battery placement	6
2.3 Battery supporting materials	8
3. Introduction to TOPBAND series batteries	8
3.1 Main features	8
3.2 Product appearance.	9
3.3 Functional characteristics	15
3.4 Heating function	16
4. Series and parallel connection of batteries	16
4.1 Introduction	16
4.2 Parallel usage	17
4.3 Serial usage	19
4.4 Simultaneous series and parallel	20
4.5 Battery communication	21
4.5.1 Communication terminal connection	21

TOPBAND

4.5.2 Networking method:	22
4.5.3 APP interface display	24
5. Charging requirements	24
5.1 AC-DC charger	25
5.2 Photovoltaic charging	25
5.3 Charging with an AC generator through a DC-DC charger	25
5.4 Recommended charging voltage	25
5.5 Passive balance function	26
6. Battery recycling	26
7. Transportation and Storage	26
8. Warnings and reminders	26

TOPBAND



1. Safety

1.1 Statement

Please read this manual carefully before installation, operation, and maintenance, and pay attention to various warning signs and statements on the equipment. After reading this manual, please keep it properly for future reference.

1.2 Specification

This manual contents using the following symbols should be paid special attention to during operation.

Symbol	Statement
	Attention, caution, warning: Reminder of precautions during operation
	Danger, Reminder that there is a risk of electric shock during operation and protective measures need to be taken
	Explanation or reminder, Matters that require special explanation or reminder

1.3 Critical safety info.

Before installing, operating, or maintaining the battery, the following operating and maintenance instructions must be read.

Before installing

- It is very important and necessary to carefully read the user manual before installing or using the battery. Failure to follow any instructions or warnings in this document may result in electric shock, serious injury, or damage to the battery and the entire system.
- Before connecting the battery pack to your device, check the voltage and ensure that they are within the limits of your device specifications. Failure to comply with these specifications will void your warranty.

During installation:

- Personnel familiar with the electrical specifications of their country or region are required to install battery packs. For optimal safety, please follow the steps described in this manual.

Battery operation:

- ① Prohibit connecting batteries to different types of batteries;
- ② Do not use faulty or mismatched chargers to charge the battery;
- ③ The environmental conditions specified in the product specification must be followed;
- ④ If the battery is found to be deformed, abnormally hot, or emitting an odor, please immediately cut off the power and stop using it.

1.4 Battery maintaining

① Professional personnel should take care of the charging operation, ensure good contact between the plug and socket during the charging process, ensure normal operation of the charging equipment, and ensure good contact at all connection points of the battery pack. If there is an abnormality, it needs to be repaired before charging;

② If there is a large amount of dust, metal shavings, or other debris on the upper cover and pole of the battery pack, clean it with Vacuum cleaner a timely manner to avoid using water or objects soaked in water for cleaning;

③ Try to avoid splashing water or other conductive objects onto the battery cover and pole during charging and discharging, such as when exposed to heavy rain for use;

④ Estimate the charging and discharging time of the battery or battery pack based on its actual usage status. Pay attention to observing whether there are any abnormalities in the battery or battery pack at the end of charging and discharging, such as voltage difference issues;

⑤ Check whether the conductive strip, voltage collection terminal, and other nodes are loose, detached, rusted, or deformed, ensuring that the batteries used in series or parallel connection are fixed and reliable (once/3 months);

TOPBAND

1.5 Waste disposal



Please handle packaging and replace components in accordance with the laws and regulations of the country or region where the battery pack is located. Do not mix batteries with daily life.

Dispose of garbage together

2. Installation

2.1 Tools and Equipment



Insulating gloves



Safety shoes



Tool

2.2 Battery placement

Gently place the battery pack face up on the support surface, do not lay it on its side or upside down, and do not place any covers above the pack. The schematic diagram of battery pack placement is shown in Figure 3

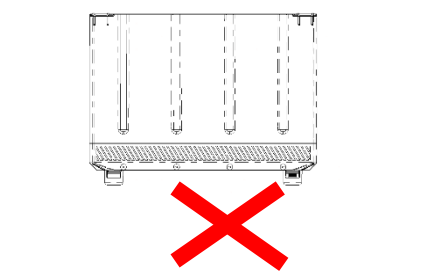
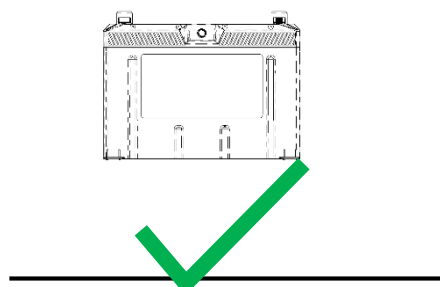

TOPBAND

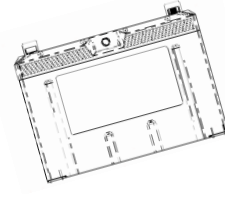
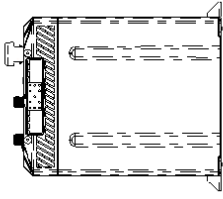

Figure 1 Installation and Placement Diagram

TOPBAND

2.3 Battery supporting materials

Table 1: Material List

SN	Material name	Chart	QTY/pc	SPEC
1	Inter-communication cable		1	500mm long, M12 circular communication interface at both ends.
2	Battery		1	12.8V100Ah or 12.8V200Ah or 12.8V300Ah
3	Screw		2	M8 * 12 stainless steel screw

3. Introduction to TOPBAND series batteries

3.1 Main features

- a. LiFePO4 chemistry - providing excellent safety and lifespan performance
- b. High reliability – with high cell consistency and balancing feature
- c. Maintain consistent performance over a wide temperature range
- d. With higher heat dissipation effect, it can maintain high current charging and discharging of the battery for long time
- e. The communication function enables the battery to communicate with external devices through CAN, enabling better battery management
- f. With built-in heater, to enable normal charging below freeze
- g. With built-in Bluetooth monitoring, to get access to detailed battery data via APP

TOPBAND

h. IP67 rating

3.2 Product appearance.

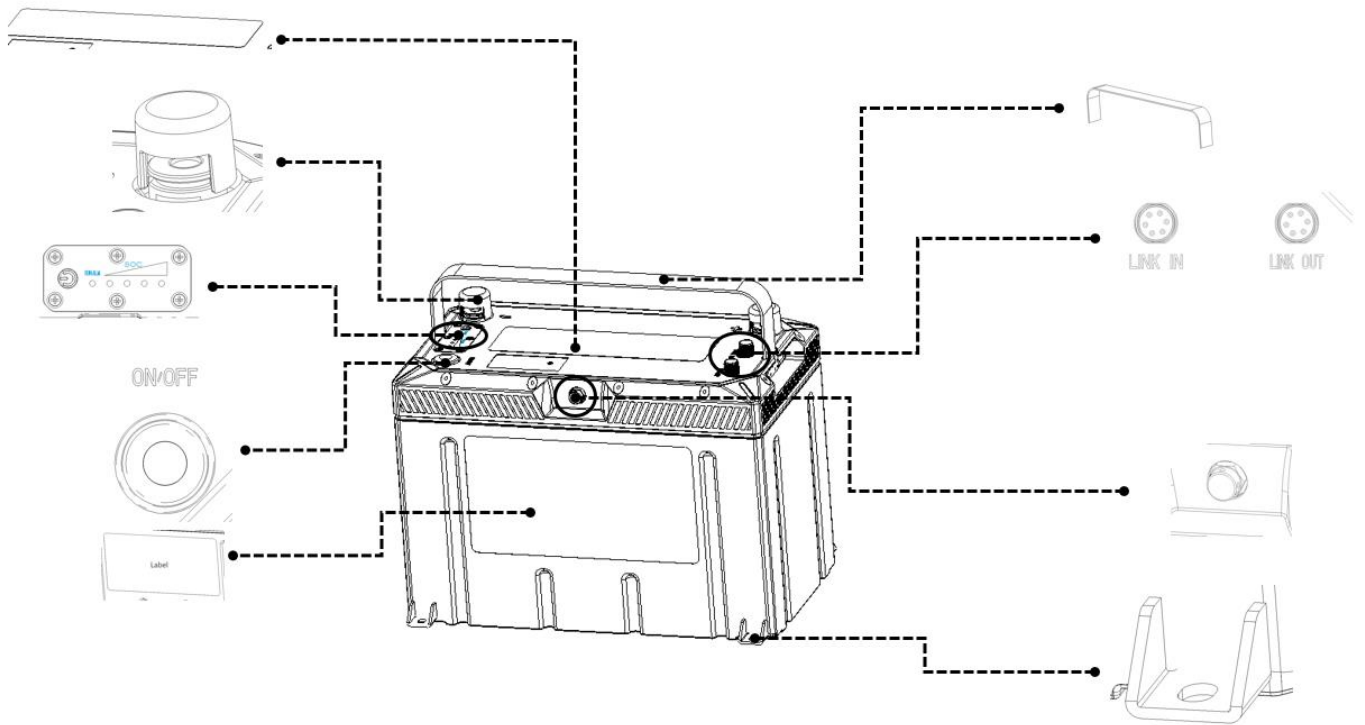
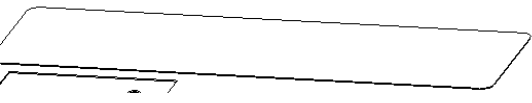
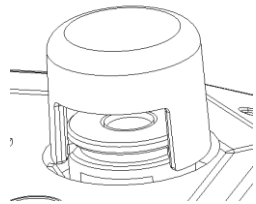

Figure 2 Battery Appearance

No.	Component Description	Name	Statement
1		Fin	Disperse the heat inside the battery, be careful not to touch it with your hands
2		Pole	M8 Terminal

TOPBAND







3		Panel	Check the SOC. running light to preliminarily determine whether the battery operates normally
4		Power Switch	When the battery is not used for a long time, it can be disconnected to reduce self-consumption.
5		Label	Carefully read the label and use the battery correctly according to the label content
6		Handle	Convenient handling of batteries
7		Port	Battery to battery communication, battery to external communication
8		Pressure relief valve	IP67 to prevent lithium batteries from exploding in special circumstances
9		Bracket	Convenient for fixing the battery on the ground

Table 1: Component Description

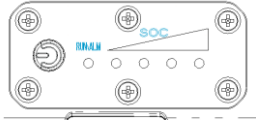
TOPBAND

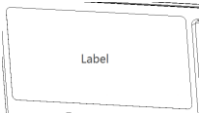
Component description:

1. Heat sink

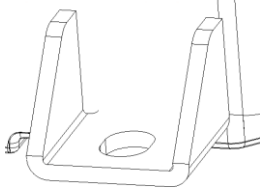
The heat sink is a battery cooling component, and rapid heat dissipation is beneficial for extending the battery life. At the same time, the heat sink is a hot decoration that cannot be touched by hand during battery use to avoid burns.

2. Pole terminal

Each battery has a positive terminal and a negative terminal. During use, be sure to identify and avoid reversing the positive and negative poles. After connecting the power line to the pole terminal, cover it with a protective cover to avoid short circuits.

3. Display panel

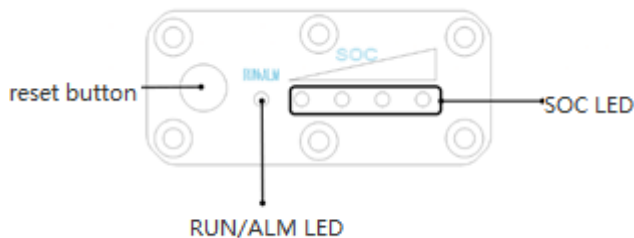

The battery display panel has 1 RUN/ALM LED, 4 SOC LEDs, and 1 button.

The usage method is as follow:

RUN/ALM: One red light, one green light, displayed in green when the battery is normal; when there is a battery failure alarm or protection, it will display in red.

Table 2: Explanation of indicator lights

Indicator light	●	Always on during charging or discharging	Flashing during standby 1
Indicator light	●	Always on when there is a malfunction	

Blinking mode	Lighting time	Off time
Blink 1	0.25s	3.75s
Blink 2	0.5s	0.5s

TOPBAND

SOC indicator lights: 4 green lights, representing different SOC according to different lighting methods.

One LED represents 25% SOC.

Status	Charge				Discharge			
SOC	L1	L2	L3	L4	L1	L2	L3	L4
0-25%	off	off	off	Blink2	off	off	off	On
25-50%	off	off	Blink2	On	off	off	On	On
50-75%	off	Blink2	On	On	off	On	On	On
75%-100%	Blink2	On	On	On	On	On	On	On

4. Battery switch

Power switch: The battery power switch is used to turn the battery on or off. When the battery is in the ON state, it indicates that the battery BMS is in a normal state and can be charged, discharged, and connected to Bluetooth;

When the battery is in the OFF state, it indicates that the battery is in a shutdown state, and cannot be charged or discharged, and cannot connect to the battery Bluetooth; the battery enters a sleep state. When the battery is not used for a long time, placing the switch in the OFF state can reduce BMS power consumption.

★ The lithium battery is equipped with an intelligent BMS, which is designed to better protect the battery cell. From the OFF state to the ON state, the BMS performs a self-check, and the self-check time does not exceed 10 seconds. Therefore; the startup time is normal within 10 seconds.

TOPBAND

Reset button: to check the battery SOC or match the battery address.

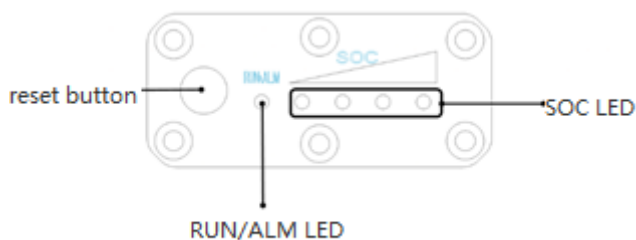

Usage method:

- ① Press for 1s, the SOC LEDs turns on for 10s. According to the number of SOC LED lights on, determine the SOC range;
- ② Long press 10s, the battery to match the networking address. During the matching process, the SOC LEDs start running. In about 5 minutes, the address matching is completed, SOC LEDs are steady on, RUN/ALM light is green on; For more details, please refer to the networking method in section 4.5.2.
- ③ Release network: when long press 10s to match the battery address, SOC LEDs start running, before the matching process completed, turn off the battery power, then the network will release, and you can't turn on the battery power button again.

5. Label

Labels are performance parameters displayed. During use, it is important to match the corresponding charger and load according to the label parameters to avoid battery failure.

6. Handle

The handle is used to bear the weight of the battery. When lifting the battery, pay attention to observing the stability of the handle to avoid the battery falling off;

7. Communication port

There are two communication ports: one is Link in and the other is Link out. Pay attention during use.

When the battery needs to communicate with external devices, a Link in needs to be connected;

TOPBAND

A: Schematic diagram of single battery usage

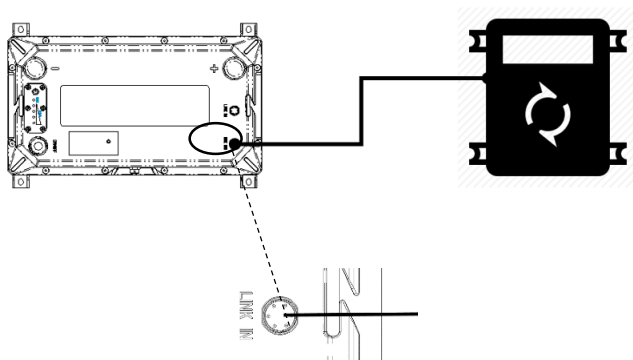

B: When multiple batteries are used in series or parallel, the external device communication line needs to be connected to the battery Link in;

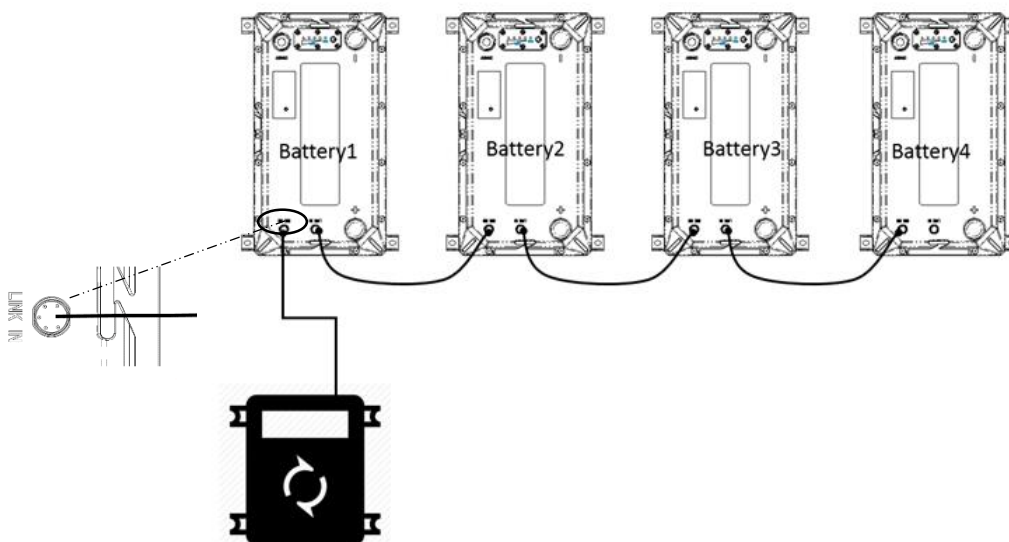

8. Pressure relief valve

The waterproof grade is IP67, because the battery is heating during charging and discharging, which leads to thermal expansion. Adding a pressure relief valve can prevent the air pressure inside the battery box from rising, resulting in dangerous accidents. Make sure that there is no other objects around the pressure relief valve.

9. Installation bracket

Install the bracket to facilitate the installation of battery in vehicles. It is recommended to use M6 stainless steel screws to secure the battery.

TOPBAND

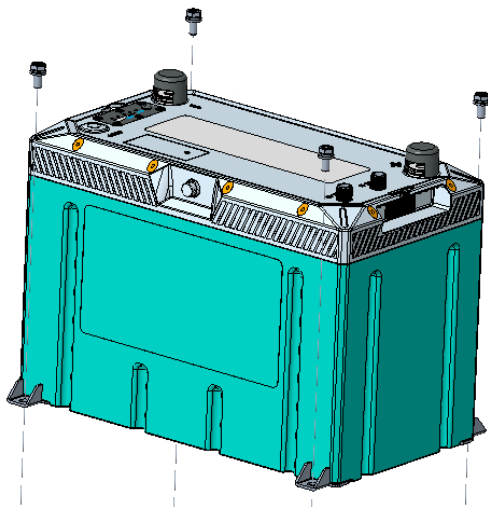

3.3 Functional characteristics

Item	12100	12200	12300
Nominal voltage	12.8V		
Nominal energy	1280Wh	2560Wh	3840Wh
Nominal capacity	100AH	200Ah	300Ah
Internal resistance@1khz AC	≤30mΩ		
Allowed MAX. charge current@ 25°C	100A	200A	300A
Allowed MIN. discharge current @25°C	150A	200A	300A
Recommend charge current	50A	100A	150A
Recommend discharge current	100A	150A	200A
Peal /Surge current limit	500A-3s	600A-3s	800A-3s
Short circuit current	1000A-500μs	1200A-500μs	1200-500μs

TOPBAND

3.3.1 First use

- ① Observe that there are no signs of the battery being disassembled;
- ② When the battery leaves the factory, the power switch will be turned off and in the OFF state;
e;
- ③ Before using the battery, it is necessary to turn the switch to the ON state, and the LED display light will be on.

3.3.2 Communication port

- ① 2 * Communication ports with CAN communication;
- ② You can upgrade the battery firmware through the communication port;
- ③ It can communicate with other devices through the communication port.

3.3.3 Power Switch

When the battery is in transportation or long-term storage, it can be turned off, which is of extremely low self-consumption, ensuring that the battery can be stored for a long time without being discharged.

At the same time, it is beneficial to improve the safety of the battery.

3.4 Heating function

The battery has a low-temperature heating function. When in cold weather, the battery is equipped with a built-in heater. When a charger is inserted, the built-in heater will automatically warm up the battery to 8°C and then switch to charging mode.

When the ambient temperature of the battery is lower than 0°C, connect the charger, the heater starts to heat, stops heating at 8°C, and changes to normal charging mode. The current of the heater comes from the charger, and the battery cannot provide energy to the heater. Please keep the charger current above 0.1C so that there is enough current to supply to the heater: e.g. 12V100Ah, ensure that the charger current is greater than $0.1 \times 100A = 10A$, otherwise it will easily cause the heater to fail to drive.

4. Series and parallel connection of batteries

4.1 Introduction

The T-Premium battery allows multiple batteries to be connected in series or parallel, as well as simultaneously connected in series and parallel. This allows for the assembly of different voltage systems a

TOPBAND

and the expansion of battery system capacity. For example, four 12.8V200Ah batteries can be connected in series and parallel to form a 25.6V400Ah battery system.

When multiple sets of batteries are connected in series and parallel at the same time, in addition to external power lines, communication lines can be connected between the batteries, and internal communication between the batteries can better obtain battery information. One battery can be set as the host battery, and the other batteries can be set as the slave battery. The host collects all information about other slave batteries, and can communicate with external devices such as inverters, display screens, MPPTs, etc.

Before connecting batteries in series or parallel, it is necessary to pay attention to:

- a). The batteries must be of the same model. Different models, different capacities, and different voltage platforms, series and parallel connection is not allowed;
- b). Ensure that all parallel wires are of the identical length;
- c). 0.5C charging is recommended, that is, charging current=rated capacity of battery * 0.5C;
- d). before connecting the batteries in series and parallel, the voltage of each group of batteries must remain highly consistent. It is recommended that the voltage difference between battery packs be:

*Voltage difference < 2000mV (@ 0%~95% SOC)

*Voltage difference<1500mV (@ 96%~100% SOC)

When battery batteries are connected in series and parallel, it will be charged and discharged as a whole system.

4.2 Parallel usage

A maximum of 16 batteries can be used in parallel. Before connecting batteries in parallel, a multimeter needs to be used to test the voltage between the positive and negative terminals of the battery. You can also check the battery voltage through the Bluetooth app to ensure that the voltage between the batteries does not exceed 2V, which can be connected in parallel. If the voltage between the batteries exceeds 2V, each battery needs to be fully charged separately, left for 1 hour, and then used in p

TOPBAND

parallel.

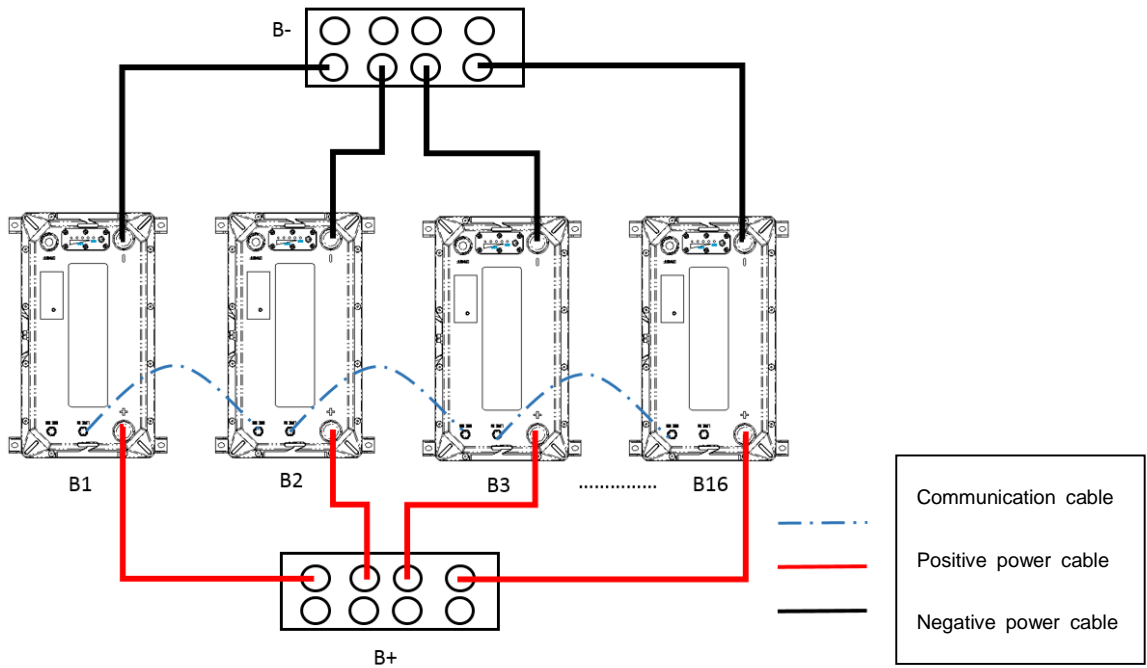
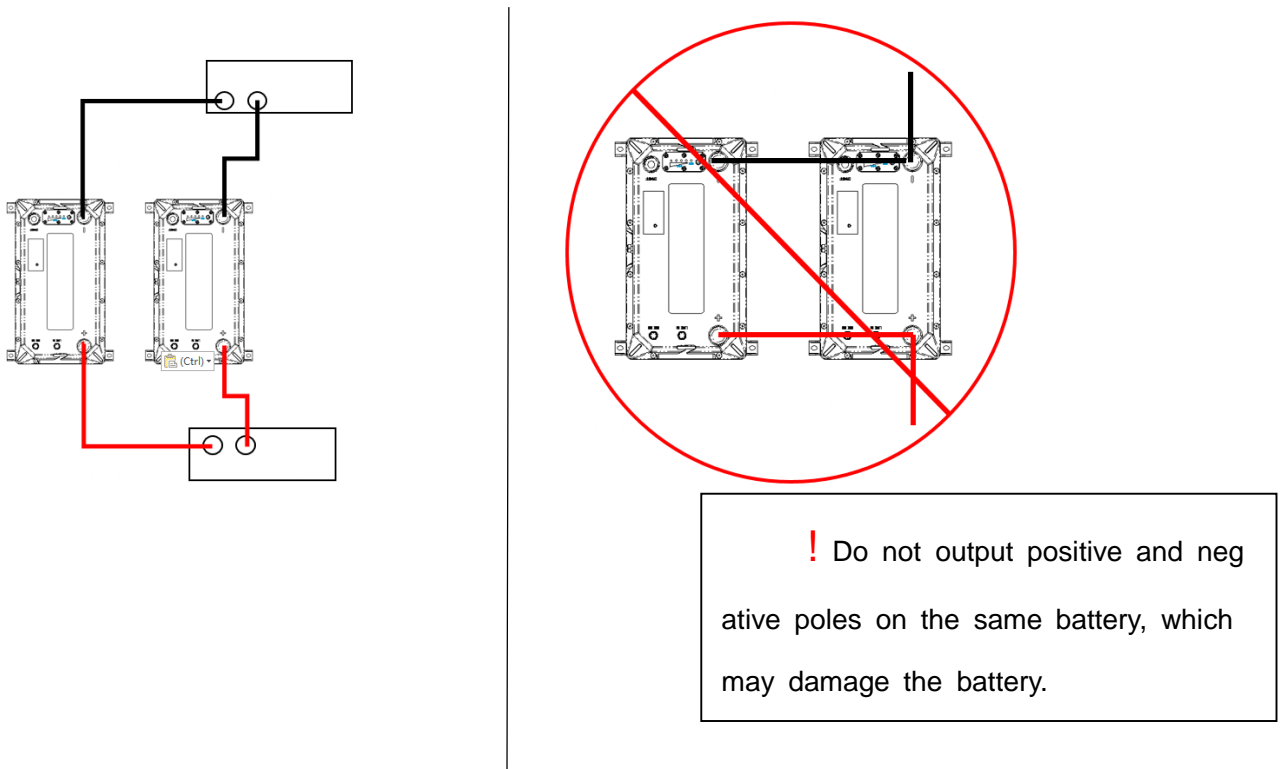

Chart 3: Wire chart

For example, two 12.8V100Ah are used in parallel



TOPBAND

System voltage: 12.8V

System capacity: 100Ah + 100Ah = 200Ah

4.3 Serial usage

A maximum of 4 batteries can be used in series. Before connecting the batteries in series, a multimeter needs to be used to test the voltage between the positive and negative terminals of the battery. You can also check the battery voltage through the Bluetooth app to ensure that the voltage between the batteries does not exceed 2V. If the voltage between the batteries exceeds 2V, each battery needs to be fully charged separately, left for 1 hour, and then used in series. Series connection method: Connect the positive pole of the battery to the negative pole of the next battery, and so on.

For example, two 12.8V100Ah batteries connected in series

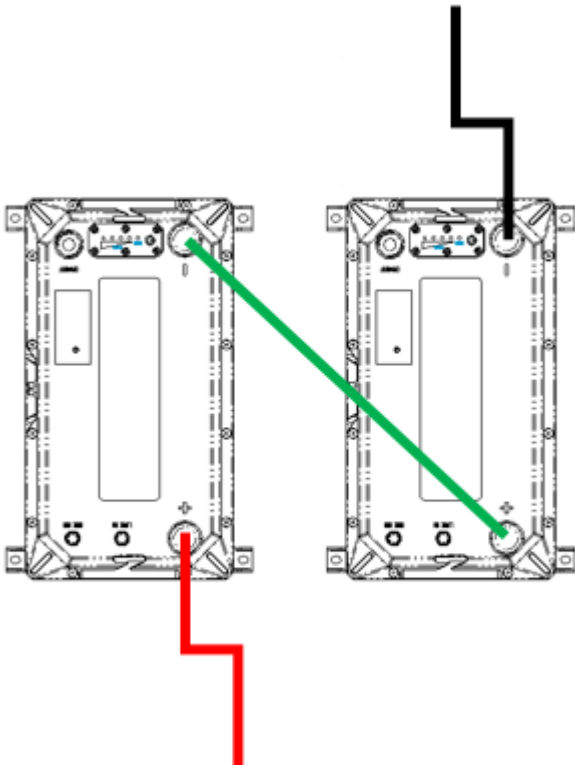

System voltage: $12.8 \times 2 = 25.6V$

System capacity: 100Ah

TOPBAND

4.4 Simultaneous series and parallel

T series batteries allow simultaneous use of batteries in series and parallel, with a maximum support of 4 series and 4 parallel applications. The connection method is: **first in series, then in parallel**, which means that the batteries are connected in series to form a high voltage, and then in parallel to form a high capacity.

Series number	Allowed parallel number
1	16
2	4
3	4
4	4

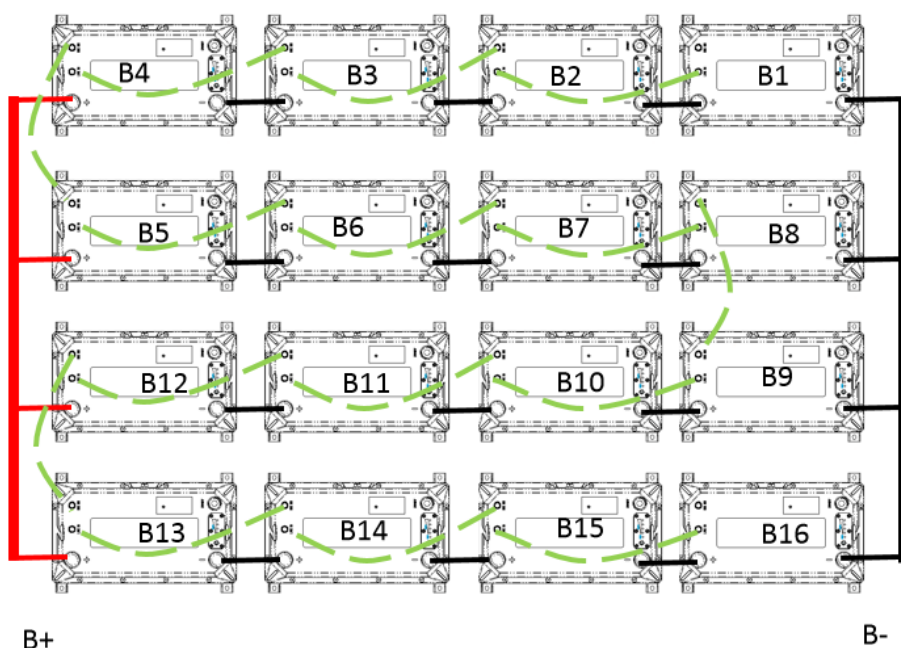

For example: 16 12.8V100Ah batteries, 4 in series&4 in parallel

System voltage: $12.8V * 4=51.2V$

System capacity: $100Ah * 4=400Ah$

TOPBAND

4.5 Battery communication

4.5.1 Communication terminal connection

The series of T-Premium batteries have the function of communication networking between batteries. When communication with external devices is needed, the networking function can be used to enable the battery to summarize information. The battery can be used alone or used for communication networking, which is more prominent in some intelligent devices. When using this function, it is important to understand its purpose and carefully read the following instructions for correct operation.

The battery includes a Controller Area Network (CAN) bus communication interface. Two circular M8 DIN connectors are located at the top of the battery to connect one battery (Link in) to another battery (Link out) using a CAN bus cable in a simple daisy link wire method.

Communication line connection method:

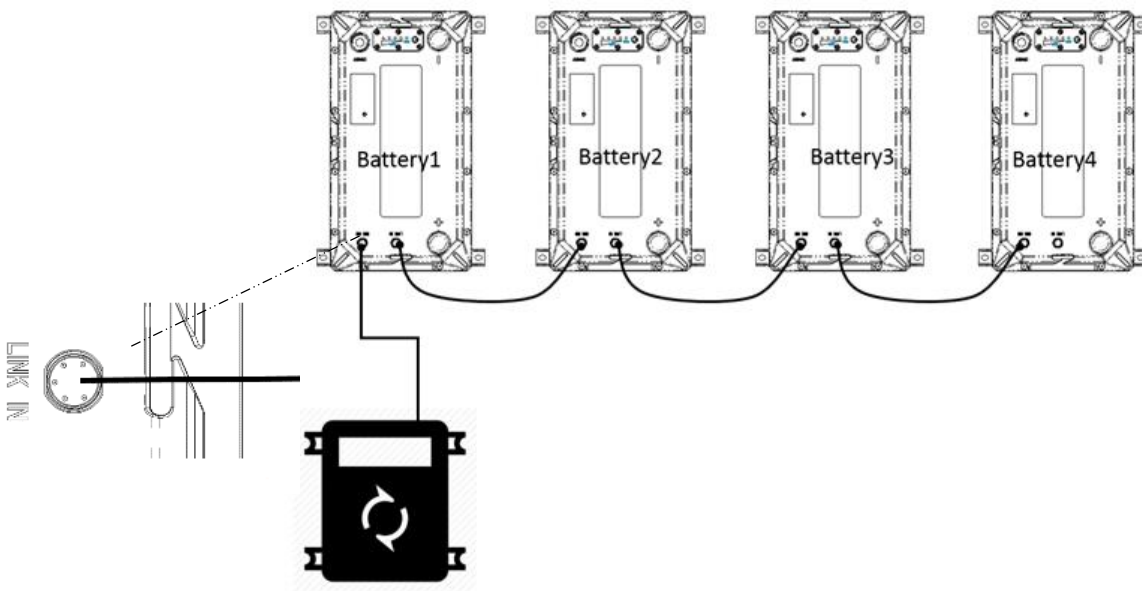

User can use an external communicated cable (optional) to connect to batteries and other device via CAN bus. This allows for communication between the battery and the load or charger, making it more efficient to use the battery. This is also beneficial for understanding battery faults. If you have mor

TOPBAND

For questions about the CAN bus, please contact Topband for technical support.

For normal battery operation, the CAN bus function is not mandatory. The battery can automatically operate and protect itself; it does not require any CAN bus communication or external devices (such as external controllers) or other CAN bus connected batteries to operate. Retain the two black covers installed on the two M12 connectors to protect them from environmental influences when not in use.

4.5.2 Networking method:

After connecting the battery through the communication cable, it is necessary to use the Bluetooth connection method through the smart APP to network the battery.

1. Equipment operation:

- ① Wiring: When all batteries are turned off, use the power line to connect the batteries in series and parallel (first in series and then in parallel); Please refer to this chapter <4.2 Parallel Use>. <4.3 Series Use>. <4.4 Simultaneous Series & Parallel Use>
- ② The battery connected to external devices serves as the first battery (Battery1), and we define this battery as the host, while other batteries are the slaves;
The LINK OUT of host battery1 is connected to the LINK IN of slave battery2,
Connect the LINK OUT of slave battery2 to the LINK IN of slave battery3; and so on.

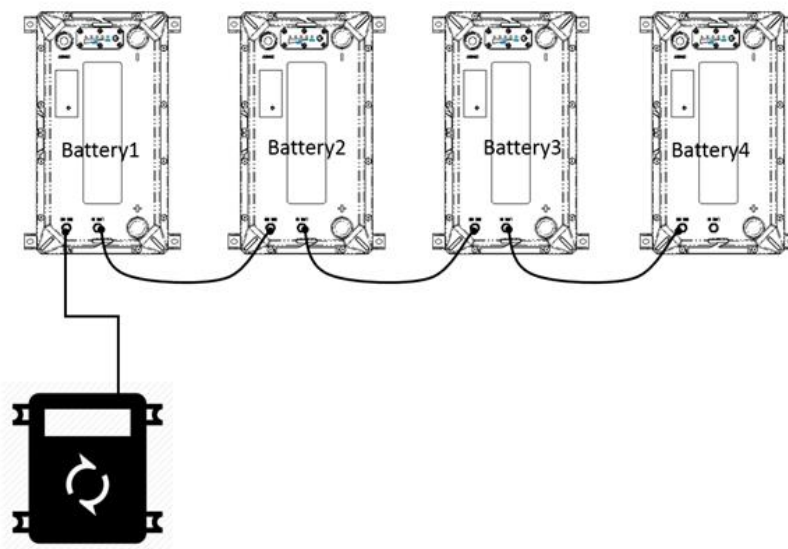

- ③ Turn on the battery power switch: switch from OFF to ON

TOPBAND

- ④ Matching address: After pressing the host battery1 reset button for 10 seconds, the SOC LEDs will start running. After all the LEDs are steady on, it means that the internal address allocation of the battery is completed;

! Attention: The battery must be connected to the power line in a series first and then in parallel mode; The communication line should first connect the first cluster of series connected batteries, and then connect the second cluster of series connected batteries, cannot mix; The matching address must be selected battery1 as the host, and long press and hold its reset button for 10s. Cannot select and press the reset button of other slave batteries. This step is particularly important as improper operation may result in battery networking failure.

2. APP operation (this step needs to match the use of the mobile app and enable the Bluetooth function of the phone):

①Networking: Open the communication networking interface of the APP, click the “+” sign, set the system name, select the voltage platform of the battery, determine the actual number of series and parallel connections, and click Next after setting;

②Connect to the host: Click on Battery1 to connect to the host battery, select the corresponding host, save, and the network distribution is successful; The device indicator light is constantly on;

- ① Maximum allowable series parallel connection for 12V batteries:

Series number	Allowed parallel number
1	16
2	4
3	4
4	4

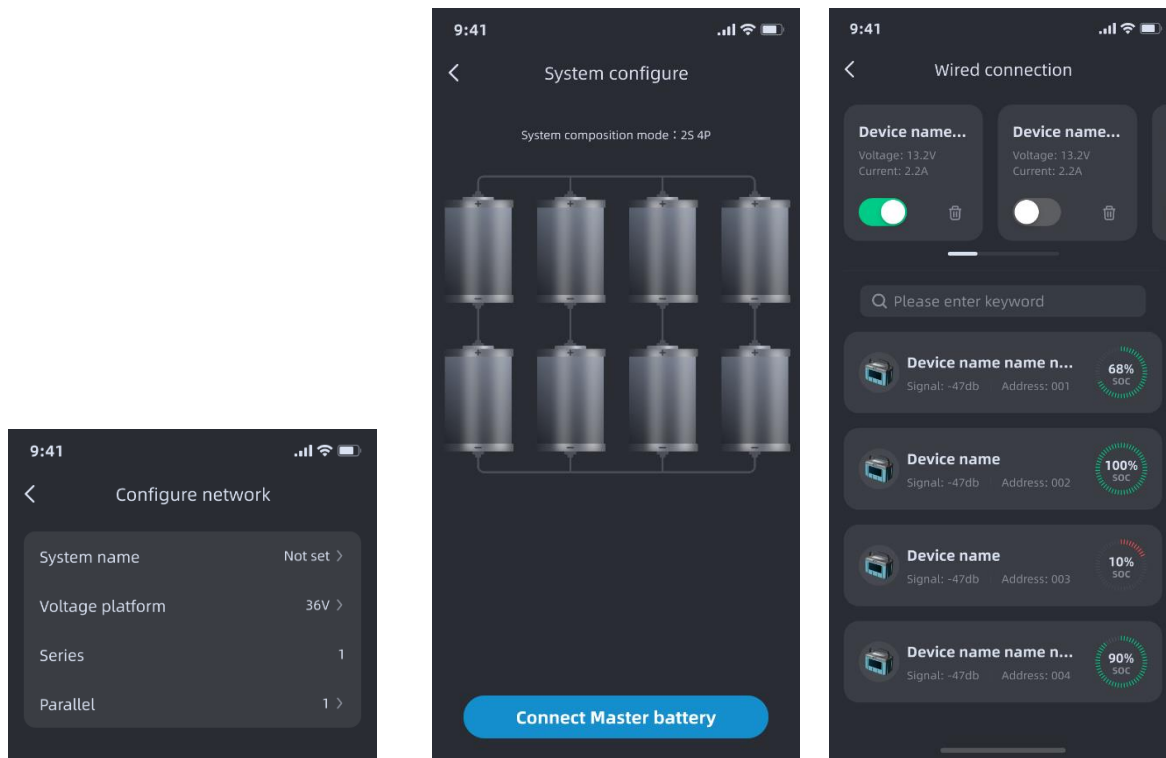

4.5.3 APP interface display

1. Support fuzzy search device: search for battery system by name;
2. System List:
 - ① Display system data: system name, system voltage, system current;
 - ② Click "+" to add system configurations, with a maximum of 6 systems saved;
 - ③ The switch can connect and disconnect the system;
 - ④ Long press to delete the system
3. Device List
 - ① Searchable device Bluetooth name, signal strength, device address, and device SOC

Please refer to the APP user manual for details.

5. Charging requirements

We recommend using a charging source with specific lithium charging settings to meet the following charging requirements to achieve the optimal performance and lifespan of TOPBAND series batteries.

TOPBAND

Model	Recommended Charge Voltage	Recommended float voltage	Cut-off Voltage	Max. Charge Current	Recommended Charge Current	Operation Temperature
48V	57.6V	54.4V	44.8V	1C	0.3C	Charge: 0 ~45°C Discharge: -20~65°C
36V	43.2V	40.8V	33.6V			
24V	28.8V	27.2V	22.4V			
12V	14.4V	13.6V	11.2V			

Note: Batteries with heating function need to be heated before switching to charging mode.

5.1 AC-DC charger

Check if the AC-DC battery charger you plan to use has a dedicated lithium charging setting that meets the above charging requirements. Many battery chargers are only designed to charge Lead-acid battery and may not have appropriate lithium charging settings.

5.2 Photovoltaic charging

Check if the solar regulator you plan to use has a dedicated lithium charging setting that meets the above charging requirements. The TOPBAND series batteries can be charged using a solar regulator without lithium charging settings. However, it must be set to charge no more than 58.4V (4 batteries in series, with a maximum charging voltage of no more than 14.6V for a single battery). After the battery is fully charged, please turn to the recommended floating voltage.

5.3 Charging with an AC generator through a DC-DC charger

Check if the DC-DC charger you plan to use has a dedicated lithium charging setting that meets the above charging requirements. You can use a DC-DC charger without lithium charging settings to charge TOPBAND series batteries. However, it must be set to charge no more than 58.4V (4 batteries in series, with a maximum charging voltage of no more than 14.6V for a single battery), and then it must be turned off after the TOPBAND series battery is fully charged. After the battery is fully charged, please turn to the recommended floating voltage.

5.4 Recommended charging voltage

We strongly recommend a dedicated charger for lithium-ion batteries to better fully charge the battery.

TOPBAND

At the same time, according to the actual situation, AGM chargers can also be used to charge the battery, which can achieve varying degrees of effect.

5.5 Passive balance function

When the battery is charged close to SOC 100%, due to the chemical characteristics of lithium batteries, the voltage difference between the cells will gradually expand. In order to ensure that each cell has the same capacity, slightly higher capacity cells will be consumed, which can allow the remaining cells to catch up.

6. Battery recycling

Topband® T-Premium lithium-ion batteries are recyclable and should not be treated as household waste or landfill waste. If you need assistance in recycling batteries, please contact your dealer or Topband.

7. Transportation and Storage

- During transportation, there should be no severe vibration, impact, or compression, and it should be protected from sunlight and rain.
- Handle with care during loading and unloading, and strictly prevent falling, rolling, and heavy pressure.
- The battery should be stored in a dry, clean, dark and well ventilated indoor environment for a long time. The recommended storage temperature range is 15~35 °C.
- The storage area is free of harmful gases, flammable and explosive materials, and corrosive chemicals.
- Batteries should be stored and transported at temperatures close to 50% SOC.
- If not used for a long time, the battery needs to be charged every 6 months according to the specifications.
- It is strictly prohibited to collapse, and the stacking should not exceed 6 layers, with the surface facing upwards.

8. Warnings and reminders

Please carefully read the battery specifications or instructions before use. Improper use may cause the

TOPBAND

battery to heat up, catch fire, rupture, damage, or decrease capacity. Shenzhen Topband Battery Co., Ltd. shall not be responsible for any accidents caused by not following our operating instructions.

Warning!

- The battery must be kept away from heat sources, high voltage, and directly exposed to sunlight.
- Do not throw the battery into water or fire.
- Do not invert the two terminals when using the battery.
- Do not connect the positive and negative poles of the battery to the conductors.
- Do not strike, throw, or step on the battery.
- Do not disassemble the battery without the manufacturer's permission and guidance.
- Do not mix batteries of different capacities and brands;

Reminder:

- It is recommended to fully charge the battery every month to correct the battery SOC.
- When the battery is over discharged, please charge the battery in a timely manner (≤ 2 days).
- Please use a dedicated lithium battery charger to charge the battery.
- Please stop using the battery when it emits odor, heat, deformation, or any abnormalities occur
- Please place the battery away from children or pets.
- If the battery pack electrolyte leaks, please avoid contact with liquids or leaked gases. If the battery pack electrolyte leaks, please take the following steps immediately:

- ① Inhalation of gas: Evacuate personnel from the contaminated area and seek medical attention as soon as possible.
- ② Eye contact: Rinse eyes with water for 15 minutes and seek medical attention as soon as possible.
- ③ Skin contact: Thoroughly rinse the exposed area with soap and water to ensure there are no chemicals or soap residues on it, and seek medical assistance as soon as possible.
- ④ Swallowing: Try to induce vomiting and seek medical attention as soon as possible.
- ⑤ Fire: Please use carbon dioxide fire extinguishers instead of liquid fire extinguishers to extinguish the fire.